

la tavola[®]

SPOTLIGHT ON FOOD

TABLE OF
CONTENTS

COMPANY PROFILE 3

FLATWARE 4

HOLLOWARE 14

SILVERWARE 20

WONDERBUFFET 26

WONDERBUFFET CONSULTING 64



la tavola[®]

WHO ARE WE ?

La Tavola is an Italian company that designs, manufactures and markets high-end tabletop items.

Our flatware patterns, modern holloware collection and classic silverware are coveted by hoteliers around the globe.

With the recent introduction of the Wonderbuffet[®], La Tavola promises to revolutionize food presentation in a buffet setting.

THE FOUNDERS

Brothers Sergio and Giulio Sambonet, having been behind the success of other prominent industry players (the Sambonet Company, Sant'Andrea and Table Top Engineering & Design), now bring a lifetime of industry-specific experience to their new company, La Tavola. Today, Matteo represents the seventh generation of the Sambonet family still filled with passion for creating beautiful and innovative table top products.

THE TEAM

La Tavola's team includes skilled engineers, architects and artisans. We strive to achieve three objectives: to be at the forefront of innovation, the most stylish and the most thorough in service.

WORLDWIDE IMPACT

La Tavola provides in-loco service and assistance through its tightknit network of worldwide distribution partners.

ROOTS

La Tavola is a proud representative of Italian creativity, design and manufacturing.





LA TAVOLA'S FLATWARE

Designing beautiful flatware is not within everyone's capability.

Good taste, sensitivity, and above all else, years of trade experience are required.

Every single item is the result of painstaking attention to detail that makes each pattern unique. To create a great flatware pattern one needs to make sure all of the right ingredients - weight, harmony of shape, proportion, ergonomics, balance - are present in exactly the right proportions.

The patterns in this collection have been designed by La Tavola's R. & D. Team under the supervision of Giulio and Sergio Sambonet.

Those personally designed by them are identified by the trademarks:



Right:
Première

Première is a
registered design by
Giulio Sambonet



la tavola



Left:
Rainbow

Right:
Yuki

Both models are
registered designs by
Giulio Sambonet





Left:
New Wave

Right:
Vegan (1)
Fusion (2)
Chill Out (3)
Lounge (4)

Vegan and Fusion
are registered designs by
Giulio Sambonet



Lounge is a registered
design by Sergio Sambonet





1



2



3



4

Left:
Norma (1)
Tosca (2)
Lucia (3)
Aida (4)

Right:
Carmen





TITANIUM COATING: A UNIQUE AND ENGAGING WAY TO PRESENT YOUR FLATWARE

Based on PVD technology (Physical Vapour Deposition), the titanium coating process allows the formation of a highly adherent film which has exceptional chemical and physical characteristics such as an extremely hard surface and high resistance to corrosion.

The titanium coating is available in Black, Gold, Venetian Gold and Platinum Champagne.



LA TAVOLA'S HOLLOWWARE

CAFE & CLUB

A hollowware line is identified by the style of its coffee and tea pots.

Those of the Cafe & Club collection are characterized by their unique lid - the one-of-a-kind knob conjures up memories of the berets of Parisian painters who, on nice spring days, would lay out their easels along the Seine river.

The harmonious silhouette created by the bone china cups of the Porcelain & Bone China collection creates a happy communion between metal and porcelain.







“THE DESIGN OF THE CAFE CLUB
LINE IS CONTEMPORARY AND
VERSATILE, WITH A LIVELY AND
DYNAMIC CHARACTER”

GIULIO SAMBONET



LA TAVOLA'S SILVERWARE

BALLET

Inspired by the silverware of the first class restaurants on luxury cruise liners that sailed the oceans at the beginning of the twentieth-century, the Ballet collection revives the opulence of that exclusive world, with a 21st century touch.

The collection sits beautifully on the tables of today's new temples of luxury, themselves the work of talented designers and stylists.

Ballet represents the height of elegance, raising the bar of tabletop presentation to new levels.







"SETTING THE TABLE WITH
BALLET CANNOT BUT INSPIRE
AN INDULGENT AND LEISURELY
DINING EXPERIENCE"

SERGIO SAMBONET



LA TAVOLA'S BUFFET

WONDERBUFFET

The Wonderbuffet is a revolution in the world of buffet equipment.

La Tavola brings to its customers a fresh design, well suited to match contemporary requirements of style.

La Tavola's Wonderbuffet features a large variety of warming, cooling and cooking functions that will excite and inspire Chefs.

We invite you to discover the functional subtleties of La Tavola's Wonderbuffet products as well as the endless possibilities of customization and personalization.



Oyster Chafer for induction



WARMING FUNCTIONS

The main challenge to maintaining heat is to make sure food retains its flavours and properties over time. La Tavola's warming functions help you achieve just that objective, with specific solutions for different dishes, service styles and power sources available.



■ ELECTRIC MULTIFUNCTION WARMING PLATES



■ MAGIC CHAFER FOR INDUCTION



■ OYSTER CHAFER FOR INDUCTION



■ COVER OVEN DRY CHAFER



■ ELECTRIC HOT WELL

COOLING FUNCTIONS

Stylish cooling solutions powered by eutectic cooling plates. Ideal for fruit and salad, yoghurt, sushi, cold cuts, beverages and ice cream. Maximum versatility of use without requiring electricity.



■ EUTECTIC COOLING PLATES



■ EUTECTIC COOLING PLATES W/COVER



■ EUTECTIC COLD WELL



■ CHILL-IT COOLING SYSTEM



■ OYSTER & FRUIT DE MER

COOKING FUNCTIONS

La Tavola's free-standing cooking stations are streamlined, practical, easy to use, clean and store.



■ COOKING STATION



■ DUAL COOKING STATION



■ COOKING & WARMING STATION



■ TEPPANYAKI STATION



Above: Electric Hot Well. Right: Chill-it Cooling System with cover

THE CHAFING DISH REVOLUTION
MAGIC CHAFER

THE MAGIC CHAFER IS THE
ONLY CHAFER THAT ALLOWS
FOR HUMIDITY CONTROL.
NO MORE SOGGY FOOD!



Right:
Induction Magic Chafar



DIFFERENT DISHES REQUIRE DIFFERENT LEVELS OF HUMIDITY TO MAINTAIN THEIR TASTE, FRESHNESS AND CRISPNESS LONGER.

TYPE OF FOOD		HUMIDITY REQUIRED	CHS® WATER PAN FILLING OPTIONS
BOILED RICE, STEAMED VEGETABLES AND FISH, ETC		HIGH HUMIDITY 	
STEWED MEAT, FISH, VEGETABLES WITH ANY TYPE OF SAUCE, ETC		LIMITED HUMIDITY 	
ROASTED AND BROILED MEATS, FRIED FOOD, BAKED POTATOES, ETC		NO HUMIDITY / DRY 	

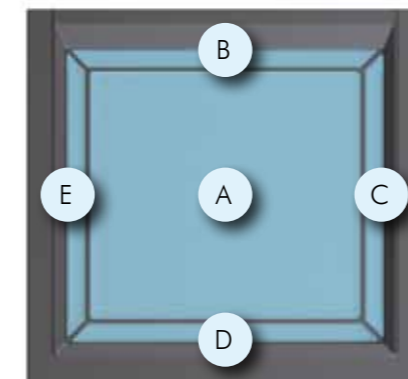

Water Pan top view

CONTROLLED HUMIDITY SYSTEM®

Thanks to its CHS® patented Water Pan, the Magic Chafer® provides the exact amount of steam necessary for any particular dish.

The CHS® Water Pan is divided into 5 compartments, a large central one (A) and 4 adjacent ones (B-C-D-E).

By filling all, some, or none of them, you will be able to control the amount of steam generated by your Magic Chafer®.



“OUR EQUIPMENT IS ELEGANT
AND MINIMALIST - THE TRUE
PROTAGONIST MUST BE
THE FOOD”

MATTEO SAMBONET

Right:
Eutectic Cooling Plate



la tavola



CUBES



CROSSES



CORNERS



HIGH & LOW



LACIE CUTS



CHECKERS CUTS

RISERS

A large range of risers is available with 3 different heights to create multi-level displays. Be creative - Cubes, Crosses, Cuts and Corners - make it as flexible as Origami!

For further personalization you can choose from a range of different finishes and colors.

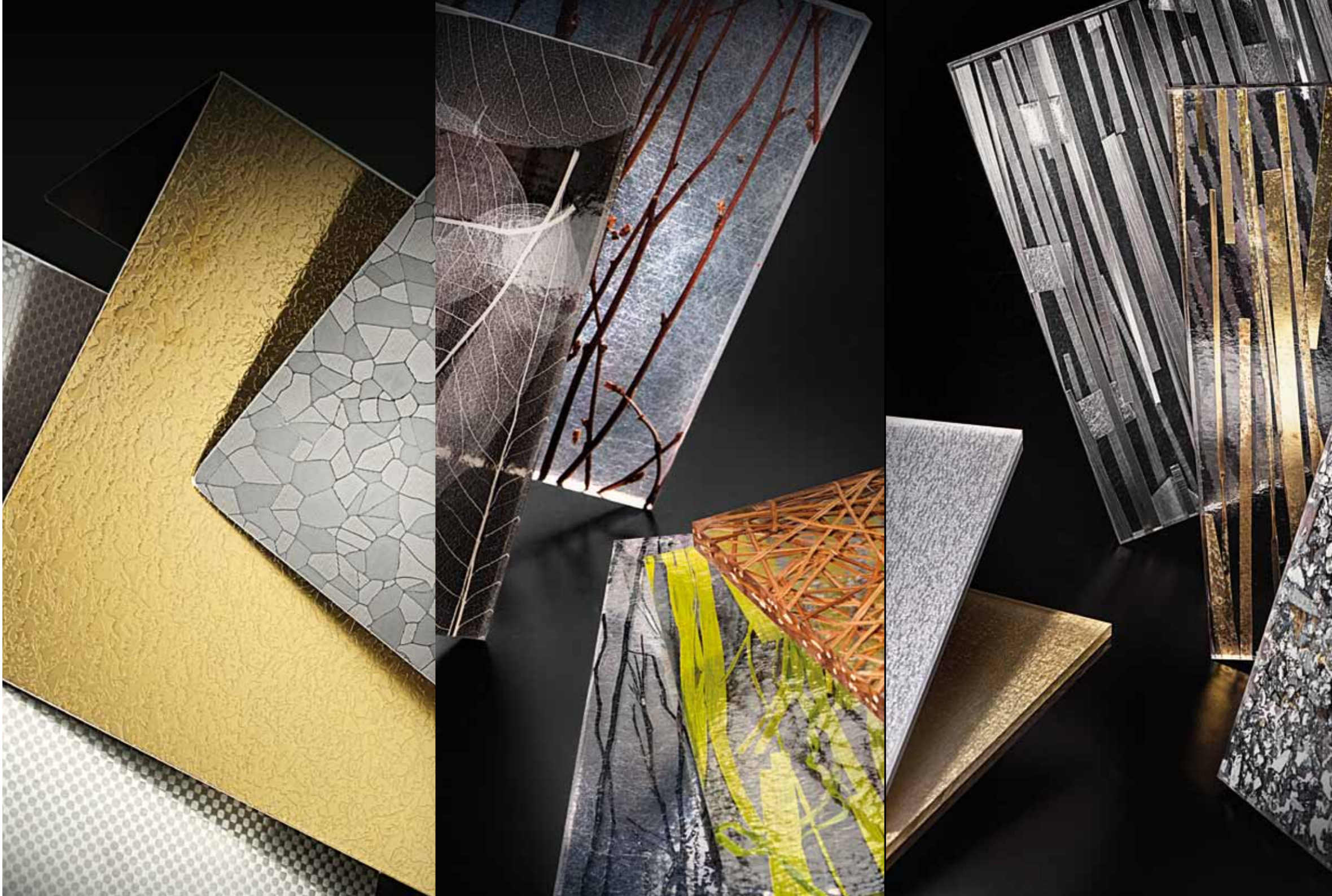

A VARIETY OF METAL COLORS,
FINISHES AND SURFACE
TEXTURES



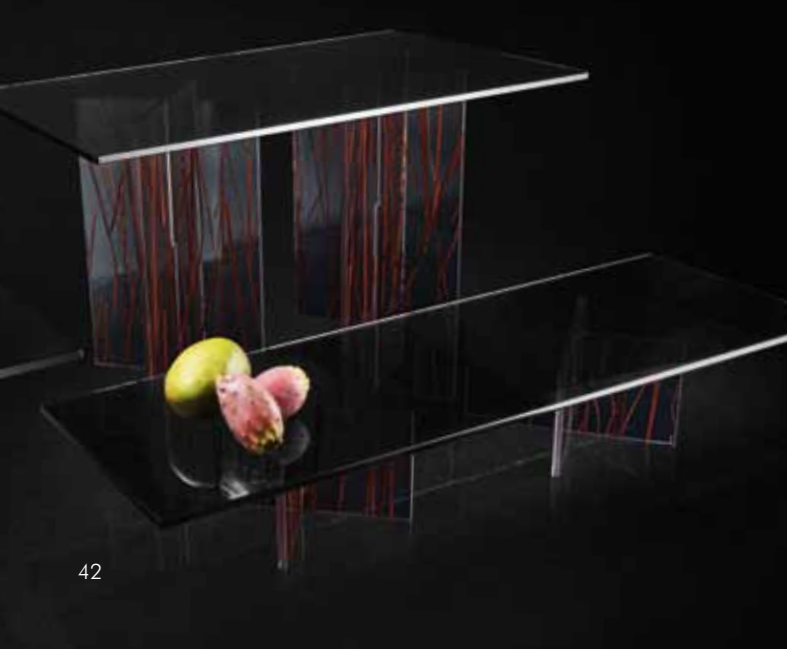

Gold Comet Silver Comet Copper Comet Gold

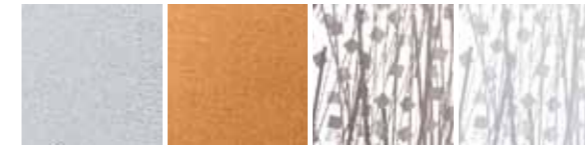

Silver Copper Gold Cosmo Silver Cosmo

MINERAL RISERS

The Mineral Riser collection offers a choice of stylish and elegant finishes. Discover the stunning combinations of different finishes.

A collection that is sure to make a statement.



ORGANIC RISERS

A collection of see-through risers made of natural materials embedded in translucent resin panels. With a wide selection of natural products used as an inter-layer, discover the best match for the look you want to achieve. This collection of eco-friendly risers (made of 40% recycled material) comes with 3 standard heights to create a dynamic presentation.





ACCESSORIES

La Tavola's wonderbuffet line is completed by a large range of accessories such as juice and milk dispensers, cereal holders, bread and fruit baskets, croissant warmers, hot beverage dispensers, bread cutting boards and much more.

BUFFET STATIONS

A DIFFERENT BUFFET EVERY DAY

Discover La Tavola's versatile food presentation solutions for banquets, ballrooms, events, break out rooms, coffee breaks, display cooking and much more.

With an unprecedented variety of functions, La Tavola's buffet stations will meet the needs of even the most demanding chefs.

La Tavola's buffet stations feature a unique design, countless possibilities in terms of customization and the use of proprietary and patented technologies.

The **D Dynamic Built-In Modular System®** is the heart of La Tavola's Buffet Stations and enables operators to experience the most flexible buffet system currently on the market.





CREATE YOUR VERY OWN STATION

With a variety of platforms to choose from, dozens of different built-in functions and a wide choice of materials and finishes, creating your very own buffet stations is easy and fun.



STEP 01 CHOOSE YOUR PLATFORM



MAGIC TABLE



MOBILE BRIDGE



NESTING TABLE



MAGIC CART



MAGIC COUNTER FRAME

STEP 02 CHOOSE YOUR FUNCTIONS from more than 40 warming, cooling and cooking functions.

For example:



INDUCTION WARMING PLATE



MAGIC CHAFER



CARVING SET



ELECTRIC WARMING TOP



HOT SOUP TERRINE & COCOTTE



DRINK & WELCOME ICE COUNTER



COLD DRINKS EUTECTIC SET



EUTECTIC COOLING TOP



EUTECTIC COLD WELL

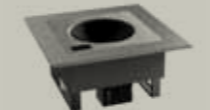

INDUCTION WOK

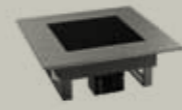

INDUCTION COOKING

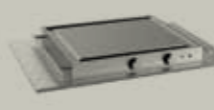

TEPPANYAKI GRILL

STEP 03 CHOOSE YOUR TOPS & SIDES from several finishes and materials

For example:



BLACK MARQUINA

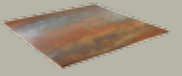

RUST



BLACK STEEL

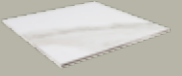

CALACATTA PURE WHITE

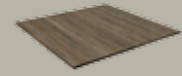

COLONIAL



MAGMA



LAVA STONE



LIGHT BROWN



HI-TECH WOOD ELM



HI-TECH WOOD OAK

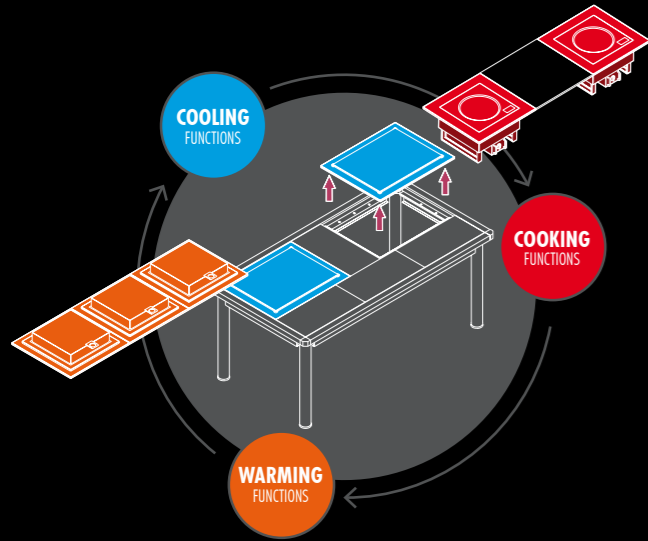

D DYNAMIC BUILT-IN MODULAR SYSTEM®

The Dynamic Built-In Modular System® gives La Tavola's buffet stations total versatility, with over 40 WARMING, COOLING and COOKING functions available.

THE MOBILE FRAME CAN BE ADJUSTED TO ACCOMODATE FUNCTIONS OF DIFFERENT SIZES

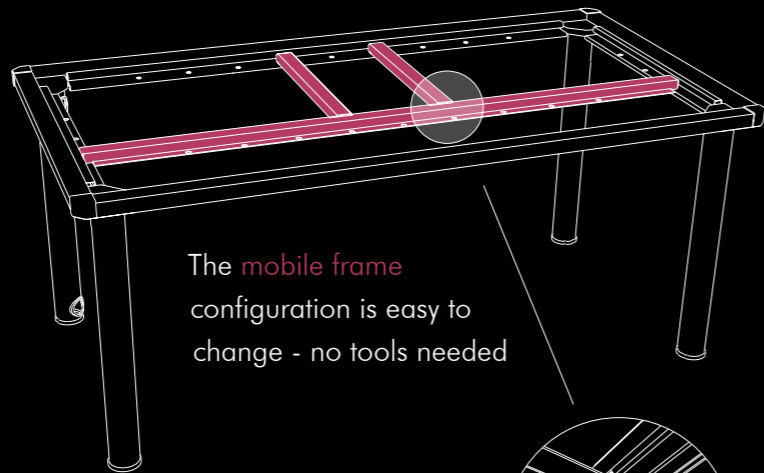

The mobile frame configuration is easy to change - no tools needed

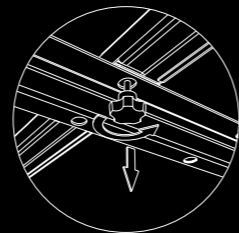

THE DYNAMIC BUILT-IN MODULAR SYSTEM®
EXAMPLES OF MOBILE FRAME CONFIGURATIONS

	MOBILE FRAME CONFIGURATIONS	SET-UP EXAMPLES	
3 SMALL FUNCTIONS			PLATFORM Magic Table (190 x 100 cm) FUNCTIONS 3 Induction Warming Tops TOPS 3 Black Tiles (cm 60 x 30)
2 MEDIUM FUNCTIONS			PLATFORM Magic Table (190 x 100 cm) FUNCTIONS 2 Eutectic Cooling Tops TOPS 4 Black Tiles (cm 60 x 30)
2 LARGE FUNCTIONS			PLATFORM Magic Table (190 x 100 cm) FUNCTIONS 2 Cooling plates with transparent cover TOPS 3 Black Tiles (cm 60 x 30)
2 EXTRA LARGE FUNCTIONS			PLATFORM Magic Table (190 x 100 cm) FUNCTIONS 2 Fruits de mer sets TOPS -

NOTE: All La Tavola platforms (Magic Table, Mobile Bridge, Nesting Table, Magic Cart and Magic Counter frame) feature the Dynamic Built-in Modular System®



Magic Tables
where beauty and
functionality meet
versatility



Magic Table Cart: stores up to 6 Magic Tables size 190x70 cm and up to 4 Magic Tables size 190x100

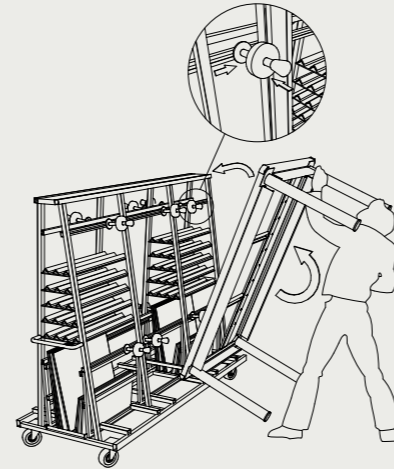

D MAGIC TABLE

PLATFORM MATERIAL
Stainless
Steel

TOPS
High Tech Ceramic or
High Pressure Laminate

SIZES
8 sizes
available

MOBILITY
Disassembled,
on dedicated cart

STORAGE
Up to 6 disassembled
tables per cart

FUNCTIONAL FURNITURE:
HIGH-END DESIGNER
TABLE AND BUFFET
STATION ALL IN ONE









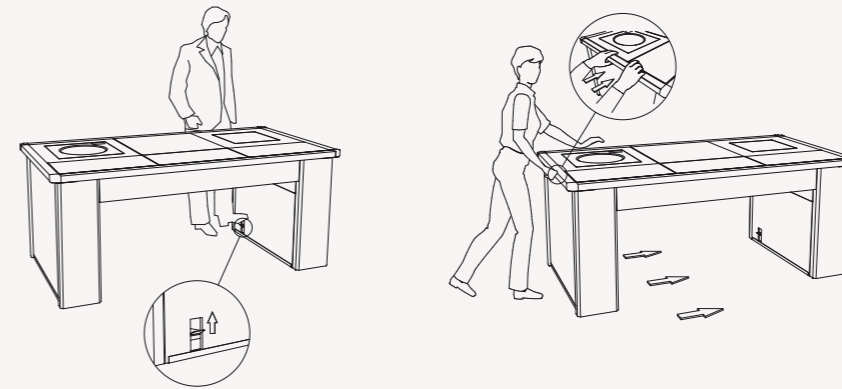

Mobile Bridge
re-defining the look
of mobile buffet
equipment



The Mobile Bridge's wheels are concealed by the inner and outer side panels and the lever to lock and unlock the wheels is easily accessible at all times



D MOBILE BRIDGE

- 
PLATFORM MATERIAL
 Stainless Steel
- 
TOPS
 High Tech Ceramic or High Pressure Laminate
- 
SIDE PANELS
 High Pressure Laminate
- 
SIZES
 2 sizes
 (190 x 100 cm and 190 x 70 cm)
- 
MOBILITY
 4 hidden wheels
 (2 with brakes)
- 
STORAGE
 N.A.

THE MOBILE BRIDGE IS AN EXPRESSION OF FINE ITALIAN DESIGN AND HANDMADE CRAFTSMANSHIP



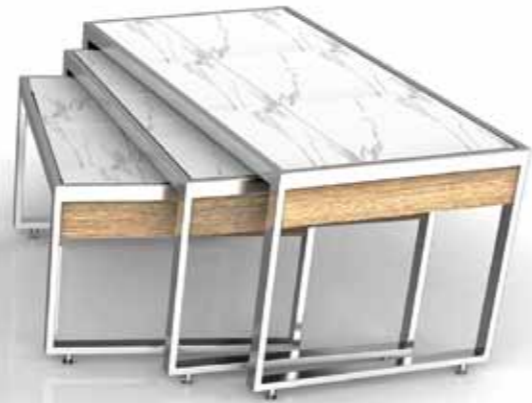

Nesting Tables
versatility and
design without
compromise



The Oblong Nesting Table is also available without casters



NESTING TABLE



PLATFORM MATERIAL

Stainless Steel



TOPS

High Tech Ceramic or High Pressure Laminate



SIDE PANELS

High Pressure Laminate



SIZES

6 standard sizes with 3 different heights or customized



MOBILITY

On casters or on dedicated cart



STORAGE

Nest three tables in the space of one

NESTING TABLES ARE A GREAT WAY TO SET UP A MOBILE BUFFET QUICKLY AND ACCORDING TO YOUR NEEDS











Magic Carts
a new frontier
in food service



D MAGIC CART

- 
PLATFORM MATERIAL
 Stainless Steel
- 
TOPS
 High Tech Ceramic and High Pressure Laminate
- 
SIDE PANELS
 High Pressure Laminate
- 
SIZES
 2 sizes available
- 
MOBILITY
 On casters
- 
STORAGE
 N.A.

A DESIGNER CART
WITH THE EXTREME
VERSATILITY OF
THE DYNAMIC BUILT-IN
MODULAR SYSTEM



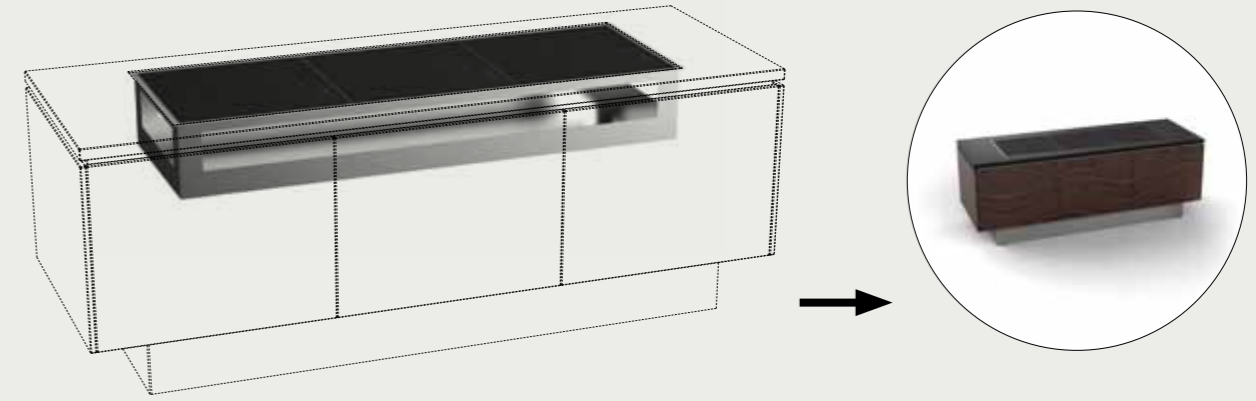



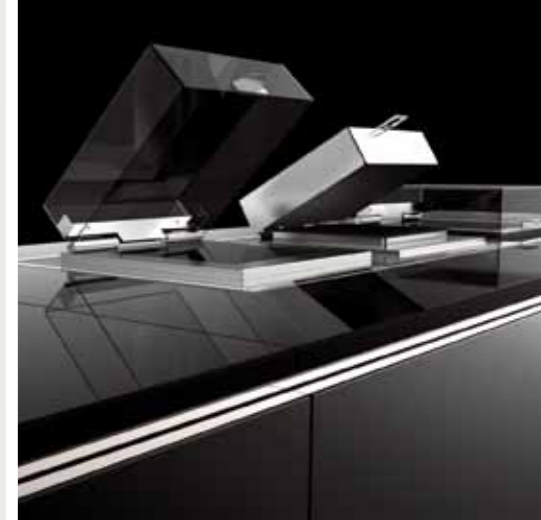

Magic Counter Frame
the only flexible solution for fixed counters



D MAGIC COUNTER FRAME

- 
PLATFORM MATERIAL
 Counter of your choice
- 
TOPS
 Surface of your choice
- 
SIZES
 10 standard sizes or customized
- 
MOBILITY
 N.A.
- 
STORAGE
 N.A.

THE ELEGANCE OF
BUILT-IN FUNCTIONS
WITHOUT THEIR
TRADITIONAL
INFLEXIBILITY





LA TAVOLA'S BUFFET

WONDERBUFFET CONSULTING

Discover a variety of special components, customization options and luxury finishes & materials!

Let La Tavola's expert design team guide you through hundreds of special components, customization options and luxury finishes & materials.

Contact us!

WE LOVE TO WORK HAND IN HAND WITH OUR
CUSTOMERS TO HELP THEM BRING THEIR IDEAS TO LIFE.

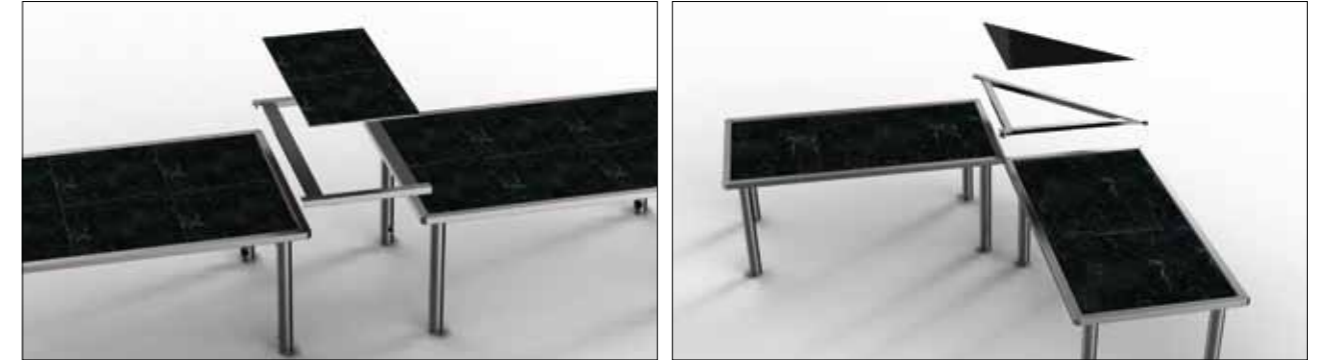

BUFFET LAYOUT & BLUEPRINT STUDY

Send us the blueprint of your buffet room and we will use it to prepare a 2D proposal.

Discover how Magic Tables can be joined together using special components such as glass top corners and extensions, to create semi-permanent buffets. Upon approval of the 2D proposal we will prepare a high resolution 3D rendering along with a price quote.

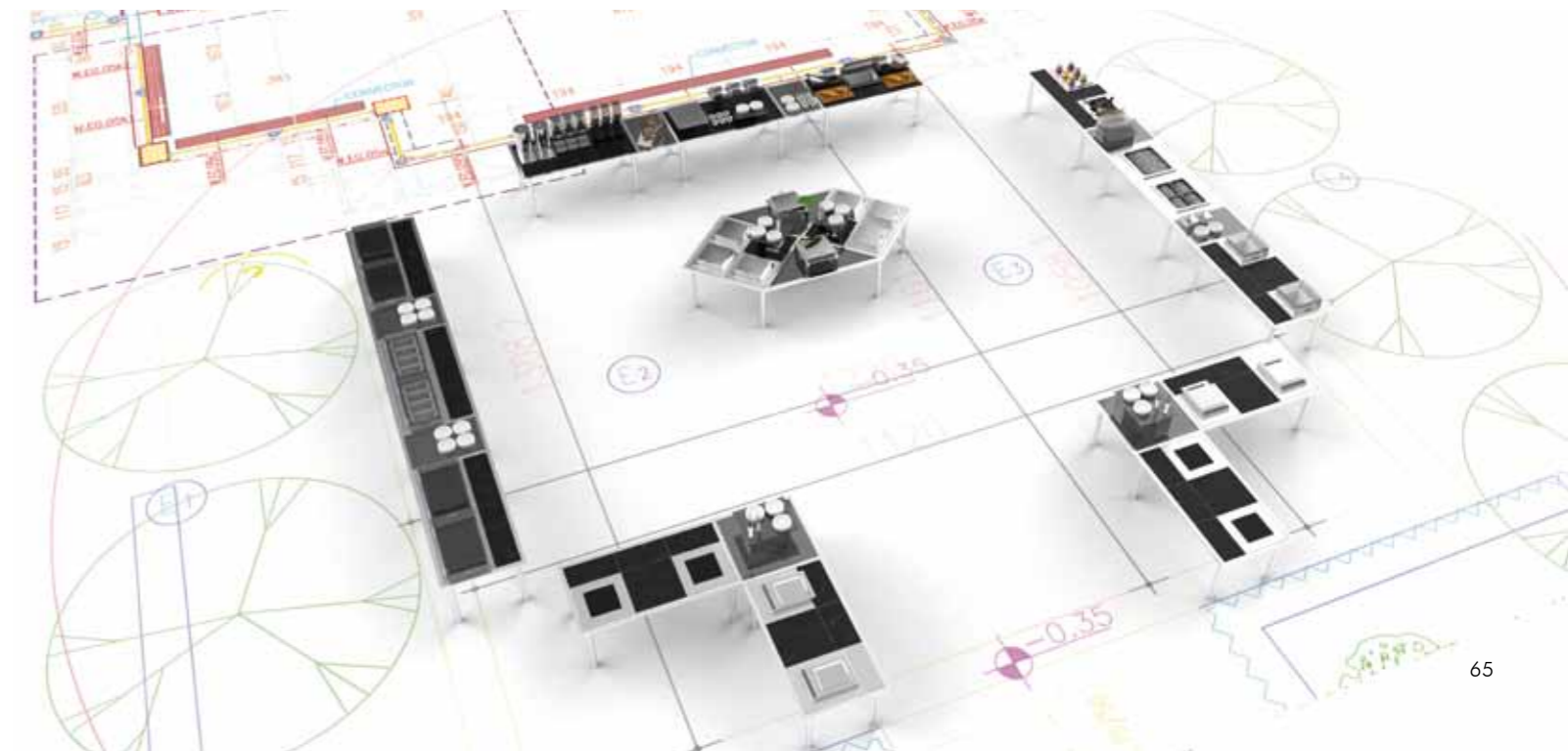



Magic Table with black corners & legs and blue classic tiles



Mobile Bridge with black corners & side bars and blue classic tiles



LUXURY FINISHES & MATERIALS

Titanium finishes for stainless steel components, luxury finishes for high tech decorative tiles, luxury finishes for Mobile Bridge side panels and much more.

FOR THOSE WHO WANT TO PUT THEIR PERSONAL TOUCH ON THEIR VERY OWN BUFFET STATIONS

XXXL table for VIP banqueting, rust tiles surrounding a center of marquinia black heated tiles centrally.



REGISTERED DESIGNS

All product designs are registered by La Tavola.
Any copy or imitation is forbidden by law.

PATENTS

Magic Chafer®, **Magic Table®**, **Cover Oven Dry Chafer®**, **Mobile Bridge®**, and **Dynamic Built-In Modular System®** are protected by international patents issued and/or currently pending.

LA TAVOLA will not hesitate to take action against any infringement in order to fully protect its intellectual property.

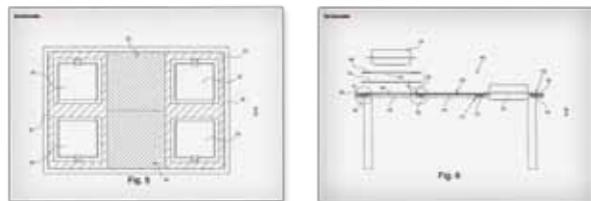

The purchasing of imitation goods may have legal implications. Design and technical information shown in this document is subject to copyright and may not be used by other parties without the written approval of LA TAVOLA.

